

The logo for COMUNELLO GATE DIVISION is located in the top right corner. It features the word "COMUNELLO" in a bold, white, sans-serif font, with a small red square containing a white stylized 'C' to its right. Below "COMUNELLO", the words "GATE DIVISION" are written in a smaller, red, sans-serif font. The background of the entire page is a dark, abstract pattern of curved, overlapping lines in shades of blue and black, creating a sense of motion and depth. Large, stylized blue geometric shapes, including a circle and a square, are overlaid on the background.

Life
made
easy

INOX GATE HARDWARE



1965-2015

Precisely 50 Years

Cinquant'anni precisi da quando il fondatore, Vittorio Comunello, ha intrapreso la sua avventura pionieristica creando un'azienda produttrice di componenti per cancelli scorrevoli che in breve conquista, e tuttora mantiene, una posizione di leader sul mercato per innovazione e ricerca della qualità assoluta.

It's precisely 50 years since our founder, Vittorio Comunello, started on his pioneering adventure to build a company for the production of components for sliding gates. The company was an instant success and has maintained its reputation and market position based on innovative solutions and an unrivalled reputation for absolute quality.

Cinquant'anni di precisione nella realizzazione di elementi perfetti, sempre al passo con l'evoluzione delle più avanzate tecnologie ed in grado di garantire i più alti standard di sicurezza.

50 years of precision in the manufacture of perfect components, maintaining pace with the evolution of the most advanced technologies while guaranteeing complete security and safety.

COMUNELLO
GATE DIVISION



Tutto, di più e meglio.

A huge range of the finest products.

I nostri **117 articoli in acciaio inox inossidabile**, di cui ora presentiamo una selezione, sono stati realizzati per assicurare **resistenza assoluta** al deterioramento ed alla corrosione in condizioni climatiche estreme come vicino al mare e per azione dell'aria salata. Gli articoli in acciaio inox sono stati progettati per tutti i sistemi di cancello: cantilever, scorrevole, battente e portone industriale.

*I nostri **117 articoli in acciaio inox inossidabile**, di cui ora presentiamo una selezione, sono stati realizzati per assicurare **resistenza assoluta** al deterioramento ed alla corrosione in condizioni climatiche estreme come vicino al mare e per azione dell'aria salata. Gli articoli in acciaio inox sono stati progettati per tutti i sistemi di cancello: cantilever, scorrevole, battente e portone industriale.*



Residential swing gates



Cerniere
Hinges

Cardini
Hinges

Battente d'arresto
Stop batten

Copri pilastri
Pillar cover



ART.

- 402i
- 405i
- 410i
- 415i
- 440i
- 450i
- 456i
- 458i
- 460i
- 470i
- 480i
- 485i
- 500i



ART.

- 86i-P
- 86i-G
- 87i-P
- 87i-G
- 84i
- 120i



ART.

- 170i



ART.

- 165i

402i

Cerniera a 2 ali con perno sfilabile
Hinge with 2 wings and extractable pivot
Paumelle avec 2 ailes et pivot à déboîter
Anschweißband 2-teilig mit lösem Zapfen
Perno de 2 palas con eje extraíble
Шарнир с 2 полками с вынимаемым штифтом

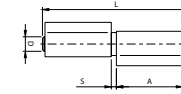

CODE	ART.	A	D	L	S	Portata - Kg Capacity	Box info	
							Pcs per pack	Kg
11604206	402i-60	26	Ø5,7	58	2	50	20	0,80
11604208	402i-80	38	Ø7,7	83	2,5	75	20	1,60
11604210	402i-100	48	Ø8,7	104	2,5	100	20	2,30
11604212	402i-120	57	Ø9,8	122	2,5	150	20	3,80
11604214	402i-140	68	Ø10,7	144	2,5	200	20	4,40

La portata è riferita ad una coppia di cerniere nel caso di peso uniformemente distribuito in un'anta con L=H.
Weight bearing capacity refers to a pair of hinges mounted on a gate with weight uniformly distributed on a leaf with proportions L=H.
Categoria commerciale: 2E

405i

Cerniera pesante a 2 ali con perno sfilabile
Heavy hinge with 2 wings and extractable pivot
Paumelle lourde avec 2 ailes et pivot à déboîter
Anschweißband 2-teilig schwere Ausführung mit lösem Zapfen
Perno pesado de 2 palas con eje extraíble
Тяжелый шарнир с 2 полками с вынимаемым штифтом

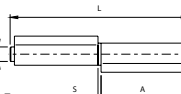

CODE	ART.	A	D	L	S	Portata - Kg Capacity	Box info	
							Pcs per pack	Kg
11604614	405i-140	68	Ø11,7	145	2,5	250	20	6,20
11604617	405i-170	83	Ø11,7	174	2,5	250	20	7,40
11604620	405i-200	98	Ø13,6	205	2,5	350	16	8,70

La portata è riferita ad una coppia di cerniere nel caso di peso uniformemente distribuito in un'anta con L=H.
Weight bearing capacity refers to a pair of hinges mounted on a gate with weight uniformly distributed on a leaf with proportions L=H.
Categoria commerciale: 2E

410i

Cerniera a 3 ali con perno sfilabile
Hinge with 3 wings and extractable pivot
Paumelle avec 3 ailes et pivot à déboîter
Anschweißband 3-teilig lösem Zapfen
Perno de 3 palas con eje extraíble
Шарнир с 3 полками с вынимаемым штифтом

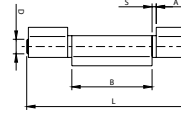

CODE	ART.	A	B	D	L	S	Portata - Kg Capacity	Box info	
								Pcs per pack	Kg
11605208	410i-80	18	38	Ø7,7	83	2,5	75	20	1,70
11605210	410i-100	23,5	48	Ø8,7	104	2,5	100	20	2,40
11605212	410i-120	27	57	Ø9,8	122	2,5	150	20	3,80
11605214	410i-140	33	68	Ø10,7	144	2,5	200	20	4,90

La portata è riferita ad una coppia di cerniere nel caso di peso uniformemente distribuito in un'anta con L=H.
Weight bearing capacity refers to a pair of hinges mounted on a gate with weight uniformly distributed on a leaf with proportions L=H.
Categoria commerciale: 2E

415i

Cerniera pesante a 3 ali con perno sfilabile
Heavy hinge with 3 wings and extractable pivot
Paumelle lourde avec 3 ailes et pivot à déboîter
Anschweißband 3-teilig schwere Ausführung lösem Zapfen
Perno pesado de 3 palas con eje extraíble
Тяжелый шарнир с 3 полками с вынимаемым штифтом

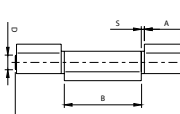

CODE	ART.	A	B	D	L	S	Portata - Kg Capacity	Box info	
								Pcs per pack	Kg
11605614	415i-140	36	62	Ø11,7	145	2,5	250	10	3,10
11605617	415i-170	44	75	Ø11,7	174	2,5	250	20	7,50
11605620	415i-200	52	89	Ø13,6	205	2,5	300	16	8,60

La portata è riferita ad una coppia di cerniere nel caso di peso uniformemente distribuito in un'anta con L=H.
Weight bearing capacity refers to a pair of hinges mounted on a gate with weight uniformly distributed on a leaf with proportions L=H.
Categoria commerciale: 2E

440i

Cernierona a 2 ali aperte perno sfilabile con rondella in ottone
Big hinge 2 open wings extractable pivot with brass washer
Paumelle grande 2 ailes ouvertes pivot à déboîter avec rondelle en laiton
Winkelband mit 2 offenen Flügeln schwere Ausführung loser Zapfen
mit Unterlegscheibe aus Messing
Perno grande de 2 palas abiertas eje extraíble con arandela de latón
Большой шарнир с 2 открытыми полками с вынимаемым штифтом с латунной шайбой

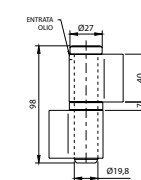

CODE	ART.	Portata - Kg Capacity	Box info	
			Pcs per pack	Kg
11607709	440i-90	800	4	2,20

La portata è riferita ad una coppia di cerniere nel caso di peso uniformemente distribuito in un'anta con L=H.
Weight bearing capacity refers to a pair of hinges mounted on a gate with weight uniformly distributed on a leaf with proportions L=H.

Categoria commerciale: 2E

450i

Cernierona a 2 ali aperte perno sfilabile con rondella in ottone
Big hinge 2 open wings extractable pivot with brass washer
Paumelle grande 2 ailes ouvertes pivot à déboîter avec rondelle en laiton
Winkelband mit 2 offenen Flügeln schwere Ausführung loser Zapfen
mit Unterlegscheibe aus Messing
Perno grande de 2 palas eje extraíble con arandela de latón
Большой шарнир с 2 полками с вынимаемым штифтом с латунной шайбой

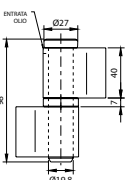

CODE	ART.	Portata - Kg Capacity	Box info	
			Pcs per pack	Kg
11608609	450i-90	400	4	2,20

La portata è riferita ad una coppia di cerniere nel caso di peso uniformemente distribuito in un'anta con L=H.
Weight bearing capacity refers to a pair of hinges mounted on a gate with weight uniformly distributed on a leaf with proportions L=H.

Categoria commerciale: 2E



Cancello battente

Swing gate

456i

Cernierona a 2 ali lunghe aperte perno sfilabile con rondella in ottone
Big hinge 2 long open wings extractable pivot with washer and bearing
Paumelle grande 2 ailes grandes et ouvertes, pivot à déboîter avec rondelle et roulement
Winkelband mit 2 langen offenen Flügeln schwere Ausführung mit lösem Zapfen, Unterlegscheibe und Kugellager
Perno grande de 2 palas largas abiertas eje extraíble con arandela de latón
Большой шарнир с 2 длинными открытыми полками с вынимаемым штифтом с латунной шайбой

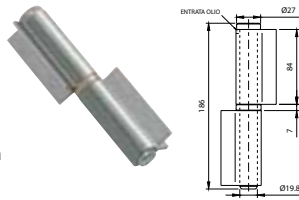

CODE	ART.	Portata - Kg Capacity - Kg	Box info	
			Pcs per pack	Kg
11609618	456i-180	800	4	4,20

La portata è riferita ad una coppia di cerniere nel caso di peso uniformemente distribuito in un'anta con L=H.
Weight bearing capacity refers to a pair of hinges mounted on a gate with weight uniformly distributed on a leaf with proportions L=H.

Categoria commerciale: 2E

460i

Cernierona a 3 ali aperte perno sfilabile con rondella in ottone
Big hinge 3 open wings extractable pivot with brass washers
Paumelle grande 3 ailes ouvertes avec pivot à déboîter et rondelles en laiton
Winkelband 3-teilig schwere Ausführung mit lösem Zapfen und Unterlegscheibe aus Messing
Perno grande de 3 palas abiertas eje extraíble con arandelas de latón
Большой шарнир с 3 открытыми полками с вынимаемым штифтом с латунными шайбами

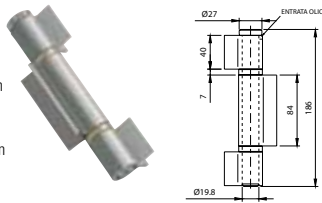

CODE	ART.	Portata - Kg Capacity - Kg	Box info	
			Pcs per pack	Kg
11611618	460i-180	800	4	4,30

La portata è riferita ad una coppia di cerniere nel caso di peso uniformemente distribuito in un'anta con L=H.
Weight bearing capacity refers to a pair of hinges mounted on a gate with weight uniformly distributed on a leaf with proportions L=H.

Categoria commerciale: 2E

480i

Cernierona a 4 ali aperte perno sfilabile con rondella in ottone
Big hinge 4 open wings extractable pivot with brass washers
Paumelle grande 4 ailes ouvertes avec pivot à déboîter et rondelles en laiton
Winkelband 4-teilig schwere Ausführung mit lösem Zapfen und Unterlegscheiben aus Messing
Perno grande de 4 palas abiertas con eje extraíble con arandelas de latón
Большой шарнир с 4 открытыми полками с вынимаемым штифтом с латунными шайбами

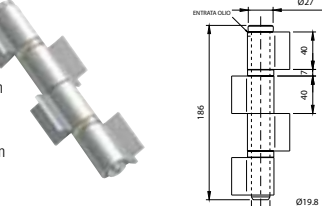

CODE	ART.	Portata - Kg Capacity - Kg	Box info	
			Pcs per pack	Kg
11613618	480i-180	800	4	4,20

La portata è riferita ad una coppia di cerniere nel caso di peso uniformemente distribuito in un'anta con L=H.
Weight bearing capacity refers to a pair of hinges mounted on a gate with weight uniformly distributed on a leaf with proportions L=H.

Categoria commerciale: 2E

500i

Cerniera a goccia tornita perno acciaio regolabile 7 mm
Turned drop hinge, 7mm adjustable, with steel pivot
Paumelle à goutte tournée, réglable 7mm. avec pivot en acier
Formgepresstes und 7 mm-verstellbares Tropfenband mit Zapfen aus Stahl
Perno gota de agua torneada eje de acero regulable 7 mm
Шарнир "капля" обточенный с регулируемым стальным штифтом 7 мм

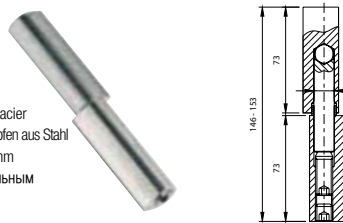

CODE	ART.	R	Portata - Kg Capacity - Kg	Box info	
				Pcs per pack	Kg
11618615	500i-150	146-153	300	10	4,00

La portata è riferita ad una coppia di cerniere nel caso di peso uniformemente distribuito in un'anta con L=H.
Weight bearing capacity refers to a pair of hinges mounted on a gate with weight uniformly distributed on a leaf with proportions L=H.

Categoria commerciale: 2E

458i

Cernierona a 2 ali lunghe chiuse perno sfilabile con rondella in ottone
Big hinge 2 closed wings extractable pivot with brass washer
Paumelle grande 2 ailes fermées avec pivot à déboîter et rondelle en laiton
Flachband 2-teilig schwere Ausführung mit lösem Zapfen und Unterlegscheibe aus Messing
Perno grande de 2 palas largas cerradas eje extraíble con arandela de latón
Большой шарнир с 2 длинными закрытыми полками с вынимаемым штифтом с латунной шайбой

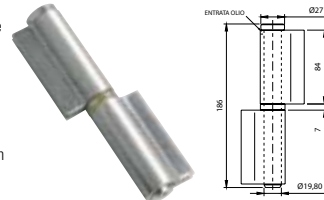

CODE	ART.	Portata - Kg Capacity - Kg	Box info	
			Pcs per pack	Kg
11610618	458i-180	800	4	4,20

La portata è riferita ad una coppia di cerniere nel caso di peso uniformemente distribuito in un'anta con L=H.
Weight bearing capacity refers to a pair of hinges mounted on a gate with weight uniformly distributed on a leaf with proportions L=H.

Categoria commerciale: 2E

470i

Cernierona a 3 ali chiuse perno sfilabile con rondella in ottone
Big hinge 3 closed wings extractable pivot with washer
Paumelle grande 3 ailes fermées avec pivot à déboîter et rondelle en laiton
Flachband 3-teilig schwere Ausführung mit lösem Zapfen und Unterlegscheibe
Perno grande de 3 palas cerradas eje extraíble con arandela de latón
Большой шарнир с 3 закрытыми полками с вынимаемым штифтом с латунной шайбой

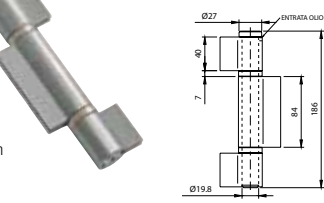

CODE	ART.	Portata - Kg Capacity - Kg	Box info	
			Pcs per pack	Kg
11612618	470i-180	800	4	4,20

La portata è riferita ad una coppia di cerniere nel caso di peso uniformemente distribuito in un'anta con L=H.
Weight bearing capacity refers to a pair of hinges mounted on a gate with weight uniformly distributed on a leaf with proportions L=H.

Categoria commerciale: 2E

PERNO ZINCATO
GALVANIZED PIN

485i

Cernierona a 4 ali chiuse perno sfilabile con rondella in ottone
Big hinge 4 closed wings extractable pivot with brass washers
Paumelle grande 4 ailes fermées avec rondelles et pivot à déboîter
Flachband 4-teilig schwere Ausführung mit lösem Zapfen und Unterlegscheiben aus Messing
Perno grande de 4 palas cerradas eje extraíble con arandelas de latón
Большой шарнир с 4 закрытыми полками с вынимаемым штифтом с латунными шайбами

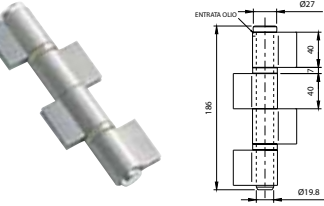

CODE	ART.	Portata - Kg Capacity - Kg	Box info	
			Pcs per pack	Kg
11614618	485i-180	800	4	4,20

La portata è riferita ad una coppia di cerniere nel caso di peso uniformemente distribuito in un'anta con L=H.
Weight bearing capacity refers to a pair of hinges mounted on a gate with weight uniformly distributed on a leaf with proportions L=H.

Categoria commerciale: 2E

86i-P

Cardine superiore con piastra
Upper hinge with plate
Gond supérieur avec platine
Oberes Torband mit Platte
Bisagra superior con placa
Верхняя петля с пластиной



CODE	ART.	Size	R	Portata Capacity	Box info	
					Pcs per pack	Kg
10800605	86i-P	Piccolo Ø 50	50-60	200 kg	2	1,7

La portata è riferita ad una coppia di cardini nel caso di peso uniformemente distribuito in un'anta con L=H.
Weight bearing capacity refers to a pair of hinges mounted on a gate with weight uniformly distributed on a leaf with proportions L=H.

Categoria commerciale: 2A

86i-G

Cardine superiore con piastra
Upper hinge with plate
Gond supérieur avec platine
Oberes Torband mit Platte
Bisagra superior con placa
Верхняя петля с пластиной



CODE	ART.	Size	R	Portata Capacity	Box info	
					Pcs per pack	Kg
10800610	86i-G	Grande Ø70	90-105	650 kg	2	4,1

La portata è riferita ad una coppia di cardini nel caso di peso uniformemente distribuito in un'anta con L=H.
Weight bearing capacity refers to a pair of hinges mounted on a gate with weight uniformly distributed on a leaf with proportions L=H.

Categoria commerciale: 2A

87i-G

Cardine inferiore con cuscinetto reggi spinta
Bottom hinge with thrust bearing
Gond inférieur avec roulement de butée
Unteres Torband mit Drucklager
Bisagra superior con placa
Верхняя петля с пластиной

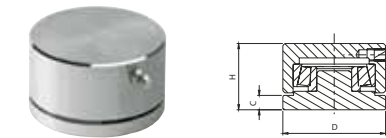

CODE	ART.	Size	C	D	H	Portata Capacity	Box info	
							Pcs per pack	Kg
10801110	87i-G	Grande Ø 70	8	Ø70	40	650 kg	2	2,0

La portata è riferita ad una coppia di cardini nel caso di peso uniformemente distribuito in un'anta con L=H.
Weight bearing capacity refers to a pair of hinges mounted on a gate with weight uniformly distributed on a leaf with proportions L=H.

Categoria commerciale: 2A

120i

Cardine con cavallotto e bussola
Hinge with u-bolt and bush
Torband mit U-Bügel und Buchse
Bisagra con pletina en U y casquillo
Петля со скобой и втулкой

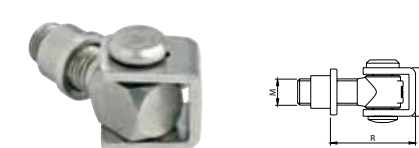

CODE	ART.	C	M	R	Portata Capacity	Box info	
						Pcs per pack	Kg
10806605	120i-M20	37	M20	45-65	150 kg	8	3,5
10806610	120i-M24	47	M24	53-75	225 kg	4	6,7

La portata è riferita ad una coppia di cardini nel caso di peso uniformemente distribuito in un'anta con L=H.
Weight bearing capacity refers to a pair of hinges mounted on a gate with weight uniformly distributed on a leaf with proportions L=H.

Categoria commerciale: 2A

165i

Copri pilastro quadrato
Square pillar cover
Couvre pilastre carré
Viereckiger Pfostendeckel
Cubrepilar cuadrado
Квадратный концевик для стойки

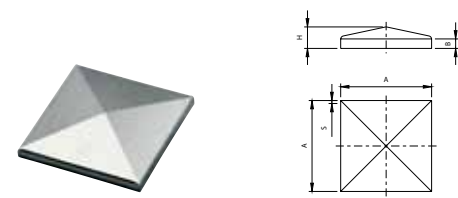

CODE	ART.	A	B	H	S	Box info	
						Pcs per pack	Kg
12100705	165i-30	35	6,5	12	1,5	10	0,3
12100710	165i-40	45	6	12	1,5	10	0,4
12100715	165i-50	55	6	13	1,5	10	0,6
12100720	165i-60	65	6,5	16	1,5	10	0,7
12100725	165i-80	85	6,5	16,5	1,5	6	0,7
12100730	165i-100	105	6,5	19	1,5	6	1,1
12100735	165i-120	125	8	26	1,5	6	1,3
12100740	165i-150	155	6,5	24,5	1,5	2	0,7

Categoria commerciale: 2G

87i-P

Cardine inferiore con cuscinetto reggi spinta
Bottom hinge with thrust bearing
Gond inférieur avec roulement de butée
Unteres Torband mit Drucklager
Bisagra inferior con rodamiento de empuje
Нижняя петля с упорным подшипником

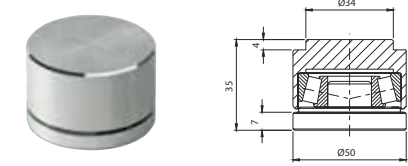

CODE	ART.	Size	Portata Capacity	Box info	
				Pcs per pack	Kg
10801105	87i-P	Piccolo Ø50	200 kg	2	1,0

La portata è riferita ad una coppia di cardini nel caso di peso uniformemente distribuito in un'anta con L=H.
Weight bearing capacity refers to a pair of hinges mounted on a gate with weight uniformly distributed on a leaf with proportions L=H.

Categoria commerciale: 2A

84i

Cardine inferiore con perno sferico
Bottom plate with spherical pin
Platine inférieur et pivot sphérique
Bodenplatte mit Drehstift
Base inferior con perno con bola
Нижняя плита со сферическим штифтом



CODE	ART.	Size	Portata Capacity	Box info	
				Pcs per pack	Kg
10800305	84i	42x42	100 kg	2	1,3

La portata è riferita ad una coppia di cardini nel caso di peso uniformemente distribuito in un'anta con L=H.
Weight bearing capacity refers to a pair of hinges mounted on a gate with weight uniformly distributed on a leaf with proportions L=H.

Categoria commerciale: 2A

170i

Battente d'arresto a cementare
Stop batten to be cemented
Battent d'arrêt à sceller
Aufschauhschuh zum Ausbetonieren
Tope para cementar
Центрируемый стопор

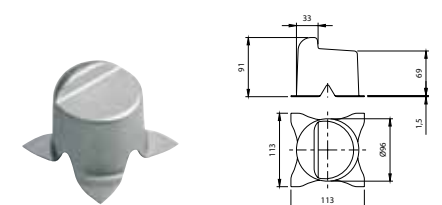

CODE	ART.	Box info	
		Pcs per pack	Kg
10701105	170i	5	1,8

Categoria commerciale: 2G

Residential sliding gates



Arresti
Stops

Monorotaie
Racks

Piastre e olive
Plates and rollers

Cremagliere
Racks

Ruote
Wheels



ART.
200i



ART.
287i
289i
291i
293i



ART.
250i
255i
230i



ART.
260i
262i
264i



ART.
300i
305i
310i
315i
335i
336i
337i
338i

300i W

Ruota gola V
Wheel with V groove
Galet avec gorge V
Schiebetorrolle mit V-Rille
Rueda canal V
Колесо с пазом V

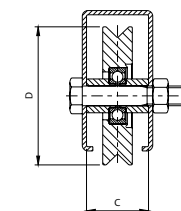

CODE	ART.	C	D	Portata ruota-Kg Capacity wheel-Kg	Box info	
					Pcs per pack	Kg
11501410	300i-V60	24	Ø 60	100	2	0,70
11501420	300i-V80	34	Ø 78	200	2	1,42
11501430	300i-V90	34	Ø 88	210	2	1,92
11501440	300i-V100	34	Ø 98	220	2	2,43
11501450	300i-V120	34	Ø 117	240	2	3,43
11501460	300i-V140	44	Ø 137	270	2	5,30
11501470	300i-V160	44	Ø 157	370	2	6,90
11501480	300i-V200	44	Ø 197	400	2	11,30

1 CUSCINETTO
1 BEARING

Categoria commerciale: 2M

310i W

Ruota gola semitonda
Wheel with half-rounded groove
Galet avec gorge demi-ronde
Schiebetorrolle mit Rundrille
Rueda canal semirredondo
Колесо с полукруглым пазом

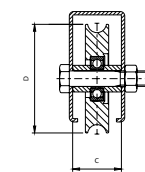

CODE	ART.	C	D	Perno Wheel Pin	Portata ruota-Kg Capacity wheel-Kg	Box info	
						Pcs per pack	Kg
11504810	310i-60	24	Ø 60	M10 x 45	100	2	0,70
11504825	310i-80S	34	Ø 78 Ø 19	M14 x 70	200	2	1,30
11504835	310i-90S	34	Ø 88 Ø 19	M14 x 70	210	2	1,70
11504845	310i-100S	34	Ø 98 Ø 19	M14 x 70	220	2	2,30
11504850	310i-120	34	Ø 117 Ø 19	M14 x 70	240	2	3,50
11504860	310i-140	44	Ø 137 Ø 19	M16 x 70	270	2	5,00
11504870	310i-160	44	Ø 157 Ø 19	M16 x 70	370	2	6,50
11504880	310i-200	44	Ø 197 Ø 19	M16 x 70	400	2	10,50

1 CUSCINETTO
1 BEARING

Categoria commerciale: 2M

335i W

Ruota con supporto interno gola V
Wheel with internal plate, V groove
Galet avec platine interne, gorge V
Schiebetorrolle mit Innenstützplatte und V-Rille
Rueda con soporte interior canal V
Колесо с внутренним суппортом с пазом V

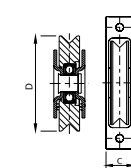

CODE	ART.	C	D	Portata ruota-Kg Capacity wheel-Kg	Box info	
					Pcs per pack	Kg
11513630	335i-V90	33	Ø 88	190	2	2,30
11513640	335i-V100	33	Ø 98	200	2	2,80
11513650	335i-V120	38	Ø 117	220	2	4,50

1 CUSCINETTO
1 BEARING

Categoria commerciale: 2M

305i W

Ruota gola V
Wheel with V groove
Galet avec gorge V
Schiebetorrolle mit V-Rille
Rueda canal V
Колесо с пазом V

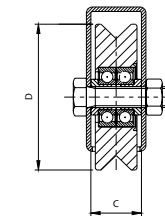

CODE	ART.	C	D	Perno Wheel pin	Portata ruota-Kg Capacity wheel-Kg	Box info	
						Pcs per pack	Kg
11502140	305i-V100	34	Ø 98	M14 x 70	400	2	3,00
11502150	305i-V120	34	Ø 117	M14 x 70	420	2	4,30
11502160	305i-V140	44	Ø 137	M16 x 70	540	2	6,60
11502170	305i-V160	44	Ø 157	M16 x 70	770	2	9,50
11502180	305i-V200	44	Ø 197	M16 x 70	800	2	15,10

2 CUSCINETTI
2 BEARINGS

Categoria commerciale: 2M

315i W

Ruota gola semitonda
Wheel with half-rounded groove
Galet avec gorge demi-ronde
Schiebetorrolle mit Rundrille
Rueda canal semirredondo
Колесо с полукруглым пазом

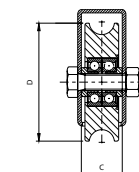

CODE	ART.	C	D	Perno Wheel Pin	Portata ruota-Kg Capacity wheel-Kg	Box info	
						Pcs per pack	Kg
11505140	315i-100	34	Ø 98 Ø 19	M14 x 70	400	2	2,70
11505150	315i-120	34	Ø 117 Ø 19	M14 x 70	420	2	4,00
11505160	315i-140	44	Ø 137 Ø 19	M16 x 70	540	2	6,30
11505170	315i-160	44	Ø 157 Ø 19	M16 x 70	770	2	9,00
11505180	315i-200	44	Ø 197 Ø 19	M16 x 70	800	2	14,50

2 CUSCINETTI
2 BEARINGS

Categoria commerciale: 2M

336i W

Ruota con supporto interno gola V
Wheel with internal plate, V groove
Galet avec platine interne, gorge V
Schiebetorrolle mit Innenstützplatte und V-Rille
Rueda con soporte interior canal V
Колесо с внутренним суппортом с пазом V

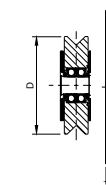

CODE	ART.	C	D	Portata ruota-Kg Capacity wheel-Kg	Box info	
					Pcs per pack	Kg
11514630	336i-V90	33	Ø 88	300	2	2,30
11514640	336i-V100	33	Ø 98	380	2	2,80
11514650	336i-V120	38	Ø 117	400	2	4,50

2 CUSCINETTI
2 BEARINGS

Categoria commerciale: 2M

337i

Ruota supporto interno gola semitonda
Wheel with internal plate, half-rounded groove
Galet avec platine interne, gorge demi-ronde
Schiebetorrolle mit Rundrinne und Innenstützplatte
Rueda con soporte interior canal semirredondo
Колесо с внутренним суппортом с полукруглым пазом

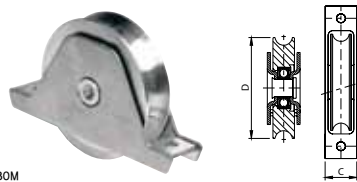

CODE	ART.	C	D	Portata ruota-Kg Capacity wheel-Kg	Box info	
					Pcs per pack	Kg
11515130	337i-90S	33	Ø88	Ø19	190	2, 2,20
11515140	337i-100S	33	Ø98	Ø19	200	2, 2,70
11515150	337i-120	38	Ø117	Ø19	220	2, 4,20



1 CUSCINETTO
1 BEARING
Categoria commerciale: 2M

338i

Ruota supporto interno gola semitonda a 2 cuscinetti
Wheel with internal plate, half-rounded groove and 2 bearings
Galet avec platine interne, gorge demi-ronde et 2 roulements
Schiebetorrolle mit Rundrinne, Innenstützplatte und 2 Kugellagern
Rueda con soporte interior canal semirredondo con 2 rodamientos
Колесо с внутренним суппортом с полукруглым пазом с 2 подшипниками

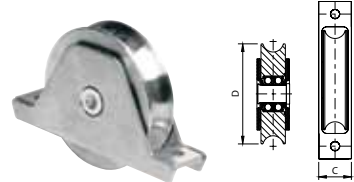

CODE	ART.	C	D	Portata ruota-Kg Capacity wheel-Kg	Box info	
					Pcs per pack	Kg
11515630	338i-90	33	Ø88	Ø19	300	2, 2,50
11515640	338i-100	33	Ø98	Ø19	380	2, 3,00
11515650	338i-120	38	Ø117	Ø19	400	2, 4,80



2 CUSCINETTI
2 BEARINGS
Categoria commerciale: 2M

287i

Binario a cementare "Pendolino"
Track to be cemented "Pendolino"
Rail à sceller "Pendolino"
Bodenlaufschiene zum Einbetonieren "Pendolino"
Carril para cementar "Pendolino"
Рельсы цементируемые "Pendolino"



CODE	ART.	L	Box info	
			Pcs per pack	Kg
10204113	287i-G-Ø19-Sp2	L=3000	1	6,0
10204114	287i-G-Ø19-Sp2	L=6000	1	12,00

Categoria commerciale: 2I

289i

Binario a fissare "Rapido"
Track to be bolted "Rapido"
Rail à visser "Rapido"
Laufschiene zum Anschrauben "Rapido"
Carril para fijar "Rapido"
Рельсы прикрепляемые "Rapido"



CODE	ART.	L	Box info	
			Pcs per pack	Kg
10201605	289i-G-Ø19-Sp2	3000	1	3,30
10201610	289i-G-Ø19-Sp2	6000	1	6,60

Categoria commerciale: 2I

291i

Spina di collegamento per binario Art. 289i - Ø19
Connection pin for track Art. 289i - Ø19
Jonction pour rail Art. 289i - Ø19
Verbindungsstift zum Laufschiene Art. 289i - Ø19
Pasador de conexión para carril Art.289i - Ø19
Соединительный штырь для рельс арт.289i - Ø15



CODE	ART.	Size	Box info	
			Pcs per pack	Kg
10602105	291i	80-Ø12,5	1	0,10

Categoria commerciale: 2I

293i

Binario a fissare "Diretto"
Track to be bolted "Diretto"
Rail à visser "Diretto"
Laufschiene zum Anschrauben "Diretto"
Carril para fijar "Diretto"
Рельсы прикрепляемые "Diretto"



CODE	ART.	Size	Box info	
			Pcs per pack	Kg
10201805	293i	L=3000	1	3,00
10201810	293i	L=6000	1	6,00

Categoria commerciale: 2I

250i

Piastra guida cancello regolabile
Drive-gate adjustable plate
Platine guide-portail réglable
Verstellbarer Torführungsbügel
Placa de guía de la puerta regulable
Пластина регулируемая направляющая ворот



CODE	ART.	R	Box info	
			Pcs per pack	Kg
11305605	250i-220	30-60	1	1,3

Categoria commerciale: 2L

255i

Piastra guida cancello a doppia regolazione
Guiding plate for gates with double adjustment
Platine guide-portail à double réglage
Torführungsbügel mit Doppelverstellung
Placa de guía de la puerta de doble regulación
Пластина направляющая ворот с двойным регулированием



CODE	ART.	Size	R	Box info	
				Pcs per pack	Kg
11306105	225i-220	Ø30	35-62	1	2,3

Categoria commerciale: 2L

230i

Oliva in nylon
Nylon roller
Rouleau en nylon
Nylon-Führungsrolle
Rodillo de nylon
Нейлоновый наконечник



CODE	ART.	D	M	Box info	
				Pcs per pack	Kg
11301310	230i-30	Ø30	M16	8	1,50
11301315	230i-40	Ø39	M16	4	1,00

Categoria commerciale: 2L

260i

Cremaigliera quadra
Square rack
Crémaillère carrée
Viereckige Zahnstange
Cremallera cuadrada
Зубчатая рейка квадратная

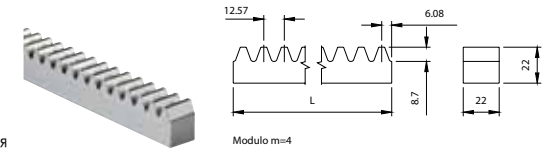

CODE	ART.	Size	Box info	
			Pcs per pack	Kg
11400610	260i-22x22	L=2000	1	6,50

Categoria commerciale: 2F

262i

Cremaigliera Rettangolare 30x12 con fori
Rectangular rack 30x12 with holes
Crémaillère rectangulaire 30x12 avec trous
Rechteckige Zahnstange 30x12 mit Bohrungen
Cremallera rectangular 30x12 con agujeros
Зубчатая рейка прямоугольная 30x12 с отверстиями

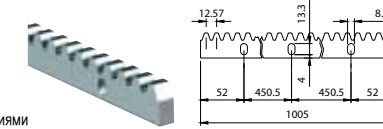

CODE	ART.	Size	L	Box info	
				Pcs per pack	Kg
11401105	262i-30x12	L=1000	1000	1	2,40

Categoria commerciale: 2F

264i

Attacco a saldare per cremaigliera rettangolare
Support for rectangular rack to be welded
Attache entretroise pour crémaillère rectangulaire
Distanzstück für rechteckige Zahnstange zum Schweißen
Fijación para soldar para cremallera rectangular
Привариваемое соединение для прямоугольной зубчатой рейки



CODE	ART.	Box info	
		Pcs per pack	Kg
11401905	264i	20	1,0

Categoria commerciale: 2F

200i-G

Arresto di fine corsa
Runaway stop
Boutoir de fin de course
Torendpuffer
Tope de final de carrera
Стопор конца хода



CODE	ART.	Size	H	Box info	
				Pcs per pack	Kg
10701610	200i-G	Grande	115	5	2,9

Categoria commerciale: 2G

Industrial gates



Terminale per monorotaia
End stopper for monorail



ART.
CGA-347P

Carrello
Carriages



ART.
CGS-350.5 AL P

Monorotaia
Monorail



ART.
CGS-345P

Incontro inferiore
Bottom end cup



ART.
CGS-346P

CGS-350.5 AL P

Carrello autoportante 5 ruote per cancelli a sbalzo
5 wheels cantilever carriage for gates
Chariot autoportant 5 roues pour portails
5-rädriger Laufwagen für freitragende Tore
Carro autoportante 5 ruedas para puertas correderas
Самонесущая тележка 5 колес для откидных ворот

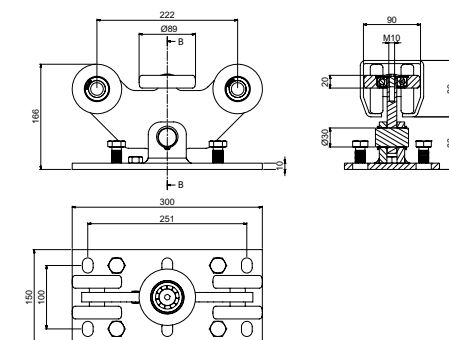

CODE	ART.	Size	Box info	
			Pcs per pack	Kg
10130305	CGi-350.5 P	Piccolo	1	11,0

Categoria commerciale: 1Q

CGi-345P

Monorotaia in acciaio inox per cancelli auto-portanti
Monorail in stainless steel for cantilever gates
Rail en aluminium extrudé pour portails autoportants
Einfachschiene aus fließgepresstem Aluminium für selbsttragende Tore
Monocarril de acero inoxidable para puertas autoportantes
Монорельс из нержавеющей стали для ворот из нержавеющей стали



CODE	ART.	Size	A	B	C	H	S	L	Box info	
									Pcs per pack	Kg
10207505	CGi-345P	Piccolo	66,5	100	33	89	5	3000	1	35,00
10207507	CGi-345P	Piccolo	66,5	100	33	89	5	6000	1	70,00

Categoria commerciale: 2R

CGi-346P

Incontro inferiore a fissare
Bottom end cup to be fixed
Butée inférieure à fixer
Unterauflageschuh zum Aufschrauben
Encuentro inferior para fijar
Прикрепляемый нижний упор



CODE	ART.	Size	Box info	
			Pcs per pack	Kg
10706005	CGi-346P	Piccolo	2	3,6

Categoria commerciale: 1T

CGi-345P

Ruota terminale per monorotaia
End wheel for monorail
Galet d'extrémité pour rail
Endrad für Einfachschiene
Rueda terminal para monocarril
Концевое колесо монорельса



CODE	ART.	Size	Box info	
			Pcs per pack	Kg
10705305	CGi-347P	Piccolo	2	3,4

Categoria commerciale: 2T

